

Frankie

Conference table and bench desk with sled base

Design — Iiro Viljanen



The metal sled base gives the Frankie conference table an upright form. Socket units and table screens available as an option.



MATERIAL DESCRIPTION:

Table tops: oak, ash, stained ash, white laminate

Base: white, black or Inspiring Colours

PRODUCT CODE NUMBER:

825D(E) = sled base, height 73 cm, metal legs

E = power outlet

Dimensional drawing:

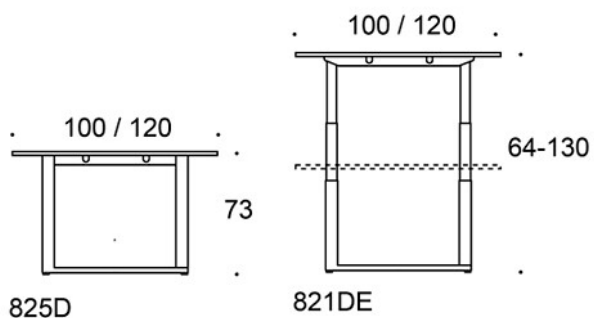
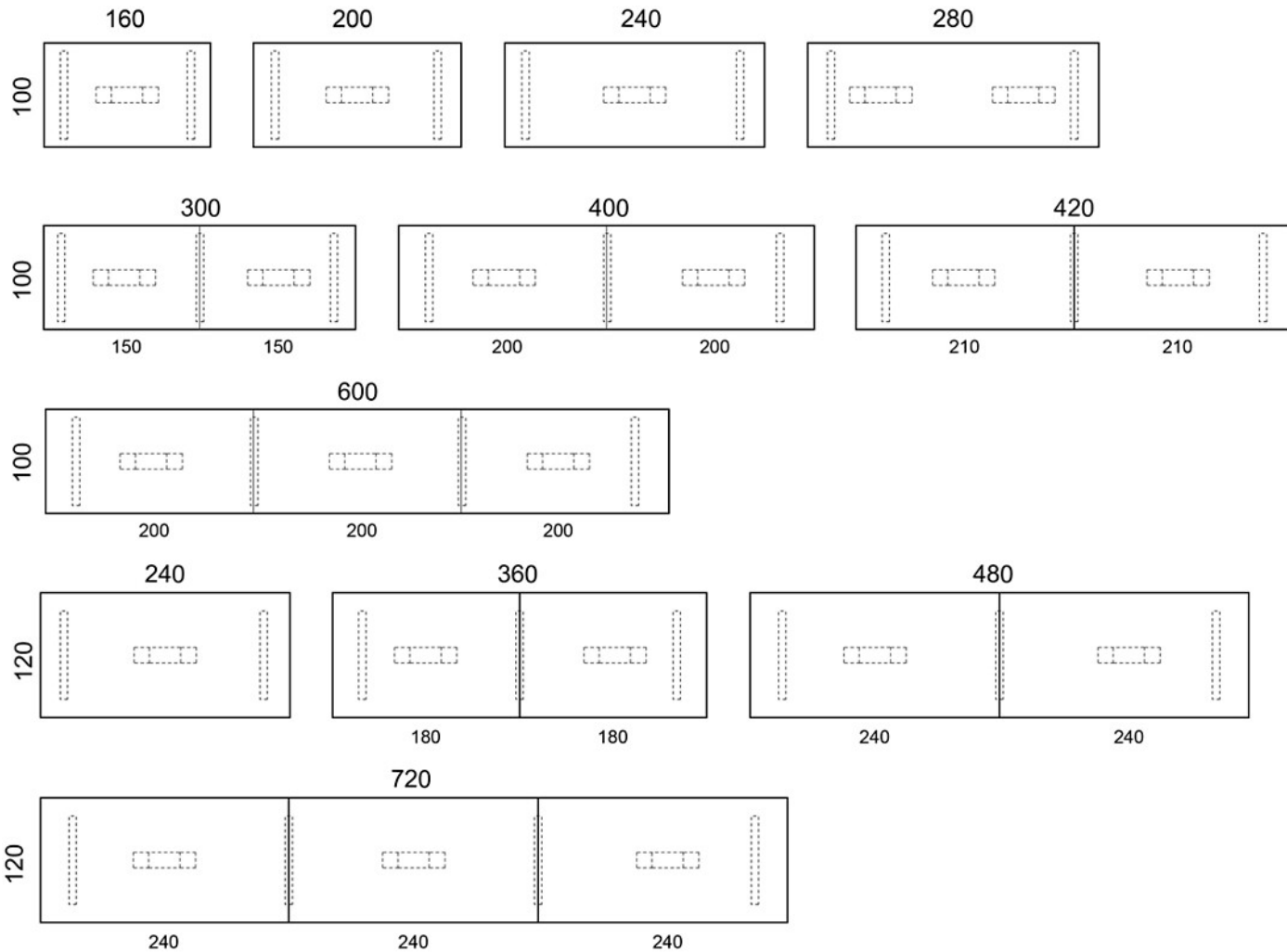

Dimensional drawing 2:

